



Cajas de empotrar y superficie para módulos 45x45

Flush/Wall mounted boxes for moduls 45x45



CAJAS DE EMPOTRAR Y SUPERFICIE PARA MÓDULOS 45x45

Flush/Wall mounted boxes for moduls 45x45

Grado de protección/degree of protection	IP30
Resistencia al impacto/resistance to impact	IK 07
Resistencia al hilo incandescente/test of resistance to glow wire	850° C partes activas/650° el resto/850° C active parts/ 650° the rest
Grado de autoextinguibilidad/auto-extinguishing degree	V0 Autoextinguible/Auto-extinguishing
Estabilidad dimensional/dimensional stability	-25°C+85°C
Presión de bola/ball pressure test	70° C
Norma aplicada/Applicable norm	UNE 20 315

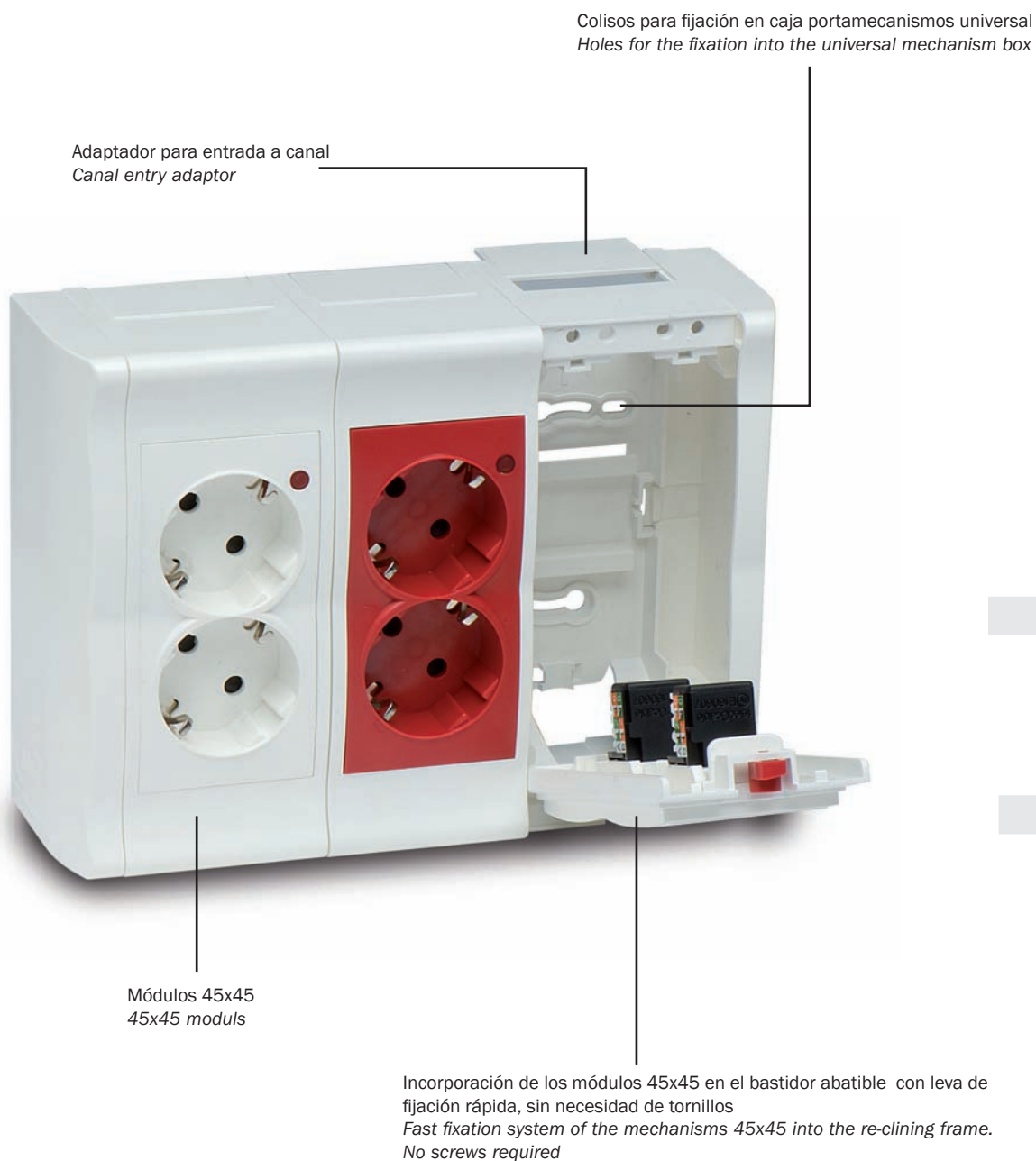

46
47

Famatec

Ref. Item. 2801

NUEVO/NEW

TOMAS DE CORRIENTE SOCKETS

4 tomas blancas TT lateral 16A-250V,
2 tomas RJ45.
4 white sockets TT lateral 16A-250V,
2 RJ45 connectors.

■	■
1	1

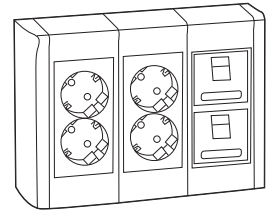

Ref. Item. 2802

NUEVO/NEW

TOMAS DE CORRIENTE SOCKETS

2 tomas blancas TT lateral 16A-250V,
2 tomas rojas TT lateral 16A-250V,
2 tomas RJ45.
2 white sockets TT lateral 16A-250V,
2 red sockets TT lateral 16A-250V,
2 RJ45 connectors.

■	■
1	1

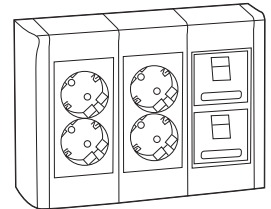

Ref. Item. 2805

NUEVO/NEW

TOMAS DE CORRIENTE SOCKETS

4 tomas blancas TT lateral 16A-250V,
2 tomas rojas TT lateral 16A-250V,
4 white sockets TT lateral 16A-250V,
2 red sockets TT lateral 16A-250V.

■	■
1	1

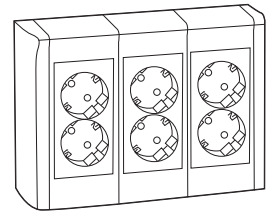

Ref. Item. 2806

NUEVO/NEW

TOMAS DE CORRIENTE SOCKETS

2 tomas blancas TT lateral 16A-250V,
2 tomas rojas TT lateral 16A-250V,
1 placa carril DIN 2 módulos.
2 white sockets TT lateral 16A-250V,
2 red sockets TT lateral 16A-250V,
1 cover DIN rail 2 MCB switches.

■	■
1	1

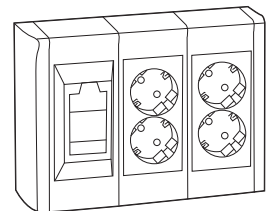

Ref. Item. 2807

NUEVO/NEW

TOMAS DE CORRIENTE SOCKETS

2 tomas blancas TT lateral 16A-250V,
2 tomas RJ45.
1 placa carril DIN 2 módulos.
2 white sockets TT lateral 16A-250V,
2 sockets RJ45.
1 cover DIN rail 2 MCB switches.

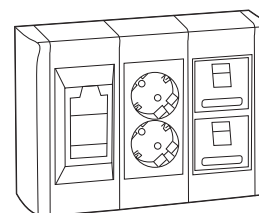

Ref. Item. 2808

NUEVO/NEW

TOMAS DE CORRIENTE SOCKETS

4 tomas blancas TT lateral 16A-250V,
1 placa carril DIN 2 módulos.
2 white sockets TT lateral 16A-250V,
1 cover DIN rail 2 MCB switches.

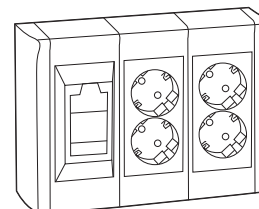

48
49

Ref. Item. 2902

NUEVO/NEW
CAJA BOX

Caja de superficie con adaptador para 2
módulos 45x45.
Surface box with adaptor for 2 moduls 45x45.

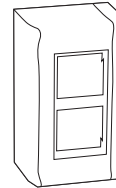

Ref. Item. 2904

NUEVO/NEW
CAJA BOX

Caja de superficie con adaptador para 4
módulos 45x45.
Surface box with adaptor for 4 moduls 45x45.

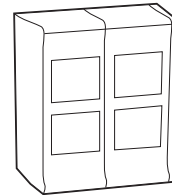

Ref. Item. 2906

NUEVO/NEW
CAJA BOX

Caja de superficie con adaptador para 6
módulos 45x45.
Surface box with adaptor for 6 moduls 45x45.

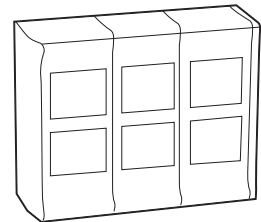

Ref. Item. 2908

NUEVO/NEW
CAJA BOX

Caja de superficie con adaptador para 8
módulos 45x45.
Surface box with adaptor for 8 moduls 45x45.

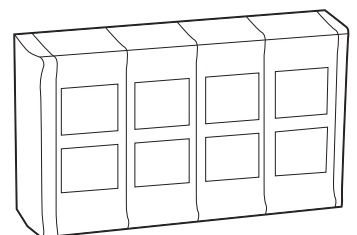

Ref. Item. 2912

NUEVO/NEW



CAJA BOX

Caja de superficie con rail DIN para bipolar + 2 módulos 45x45.
Surface box with DIN rail + 2 moduls 45x45.

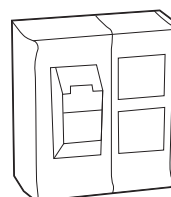

Ref. Item. 2914

NUEVO/NEW



CAJA BOX

Caja de superficie con rail DIN para bipolar + 4 módulos 45x45.
Surface box with DIN rail + 4 moduls 45x45.

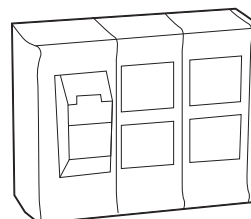

50
51

Ref. Item. 2916

NUEVO/NEW



CAJA BOX

Caja de superficie con rail DIN para bipolar + 6 módulos 45x45.
Surface box with DIN rail + 6 moduls 45x45.

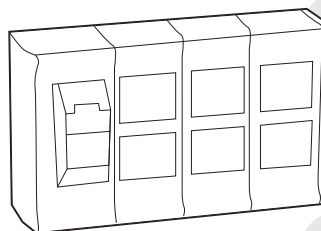

Ref. Item. 2918

NUEVO/NEW



CAJA BOX

Caja de superficie con rail DIN para bipolar + 8 módulos 45x45.
Surface box with DIN rail + 8 moduls 45x45.

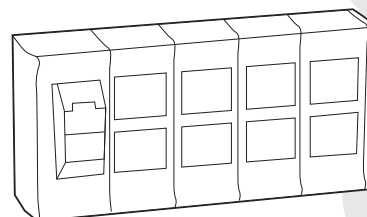

Facile

Ref. Item. 2930

NUEVO/NEW

CAJA BOX

Caja de empotrar con adaptador para 6 módulos 45x45.

Flush-mounted box for 6 moduls 45x45.

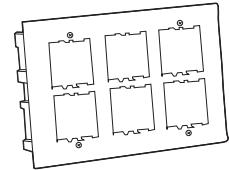
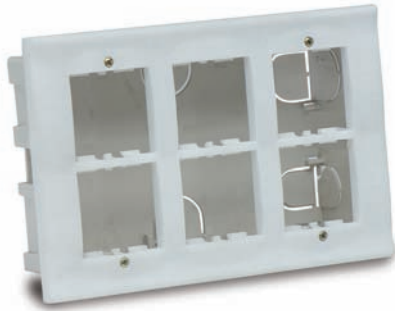

Ref. Item. 2940

NUEVO/NEW

CAJA BOX

Torreta aluminio de superficie con adaptador para 6 módulos 45x45.

Aluminium surface tower with adaptor for 6 moduls 45x45.

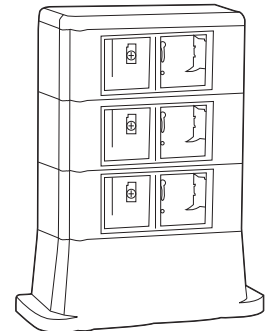

Ref. Item. 2950

NUEVO/NEW

CAJA BOX

Caja suelo con adaptador para 8 módulos 45x45.

Box for underfloor with adaptor for 8 moduls 45x45.

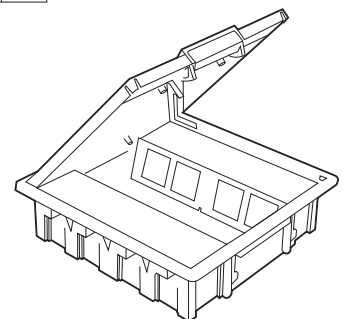

Ref. Item. 2700



INTERRUPTOR SWITCH

Doble conmutador, 10A-250V
2 way, 2 gang, 10A-250V

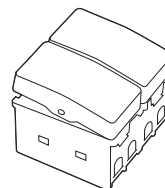
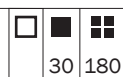

Ref. Item. 2701



INTERRUPTOR SWITCH

Conmutador + pulsador timbre,
10A 250V
2 gang, 1way + Bell push, 10A-250V

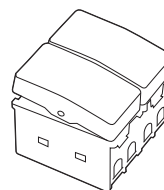
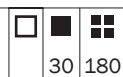

Ref. Item. 2800



TOMA DE CORRIENTE SOCKET

Con TT lateral, 16A-250V
Socket with earth, 16A-250V

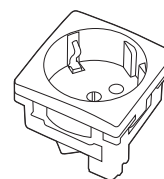
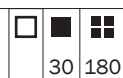

Ref. Item. 2810



TOMA DE CORRIENTE SOCKET

Con TT lateral, 16A-250V, color rojo
Socket with earth, 16A-250V, red colour

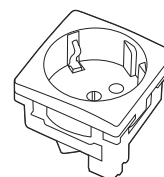
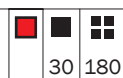

Ref. Item. 2811



TOMA DE CORRIENTE SOCKET
 Con TT francesa, 10A-250V
 French type socket, 10A-250V

<input type="checkbox"/>	<input checked="" type="checkbox"/>	<input checked="" type="checkbox"/>
	30	180

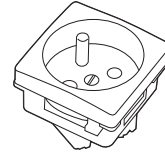

Ref. Item. 2813



NUEVO/NEW

TOMA DE CORRIENTE SOCKET
 Con TT francesa, 10A-250V. Color rojo
 French type socket, 10A-250V. Red Colour.

<input checked="" type="checkbox"/>	<input checked="" type="checkbox"/>	<input checked="" type="checkbox"/>
	30	180

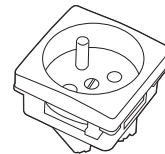

Ref. Item. 2812



NUEVO/NEW

TOMA DE CORRIENTE SOCKET
 Con TT británica, 10A-250V
 British type socket, 10A-250V

<input type="checkbox"/>	<input checked="" type="checkbox"/>	<input checked="" type="checkbox"/>
	30	180

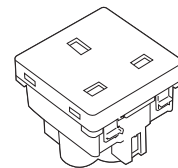

Ref. Item. 2814



NUEVO/NEW

TOMA DE DATOS DATA JACK
 Toma datos RJ45 (Incluye conector)
 Data connection RJ45 (Connector included)

<input type="checkbox"/>	<input checked="" type="checkbox"/>	<input checked="" type="checkbox"/>
	30	180

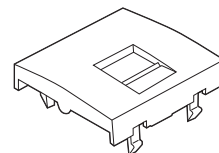

Ref. Item. 2815

NUEVO/NEW

TOMA DE DATOS DATA JACK

Toma datos doble RJ45 (Incluye conector)
Double data connection RJ45 (Connector included)

<input type="checkbox"/>	<input checked="" type="checkbox"/>	<input checked="" type="checkbox"/>
	30	180

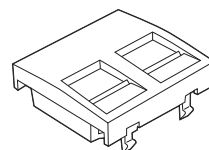

Ref. Item. 2816

NUEVO/NEW

PLACA CIEGA BLIND COVER

<input type="checkbox"/>	<input checked="" type="checkbox"/>	<input checked="" type="checkbox"/>
	30	180

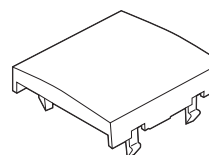

54
55