



# Clavijas y tomas industriales - Protección IP-44/67

Industrial plugs & sockets - IP-44/67 protection



**CLAVIJAS Y TOMAS INDUSTRIALES - PROTECCIÓN IP-44/67**  
*Industrial plugs & sockets - IP-44/67 Protection*

Grado de protección/degree of protection	IP-44/IP-67	
Resistencia al impacto/resistance to impact	IK 07	
Resistencia al hilo incandescente/test of resistance to glow wire	850°C 650°C	Partes activas/active parts Otras partes/other parts
Grado de autoextinguibilidad/auto-extinguishing degree	HB(UL94)	
Estabilidad dimensional/dimensional stability	-25°C+85°C	
Presión de bola/ball pressure test	125°C 80°C	Partes activas/active parts Otras partes/other parts
Norma aplicada/Applicable norm	EN 60 309-1-2	



**CONEXIONES**

Todos los tornillos de conexión están orientados en la misma dirección evitando así tener que girar la pieza durante el proceso de cableado. La fijación de los tornillos se puede realizar tanto con un destornillador plano como con uno de estrella. Todos los tornillos se suministran desatornillados para agilizar el cableado. El paso de la corriente está totalmente garantizado una vez fijados los tornillos.

**CLAMPS**

All screws of the clamps are oriented in the same direction so that it is not necessary to turn the plug or sockets during the cabling process. The tightening of all the screws can be effected with a blade or cross screw-driver. All screws are given completely unscrewed in order to get faster the cabling work.

Using the locking screws of the clamps the maximum passing of the current is guaranteed.

**PRENSAESTOPA**

Prensaestopa que garantiza una perfecta sujeción y protección del cable.

**CABLE GLAND**

Cable block gland guarantees the resistance to tearings of the cables and the protection degree.



70  
71

**DISPOSITIVO DE APERTURA**

Un dispositivo en acero niquelado facilita la apertura y cierre de las tomas y clavijas agilizando así el tiempo de cableado. Para la apertura es necesario simplemente una ligera presión con el destornillador mientras que el cierre se realiza con una simple rotación del cuerpo de la pieza.

**OPENING DEVICE**

A specific device made of nickel-plated steel allows fast opening and closing of plugs and sockets. The fast opening device reduces the cabling time as it needs just a light pressure with a tool for. For the closing it is just necessary a simple rotation.

**CALIDAD TOTAL**

La corona de las clavijas está reforzada siendo así una parte altamente expuesta a colisiones.

**TOTAL QUALITY**

The crown of the plug is reinforced as it is highly exposed to collisions and crushing.



**POSICIÓN DEL TOMA DE TIERRA**  
**EARTH POSITION**

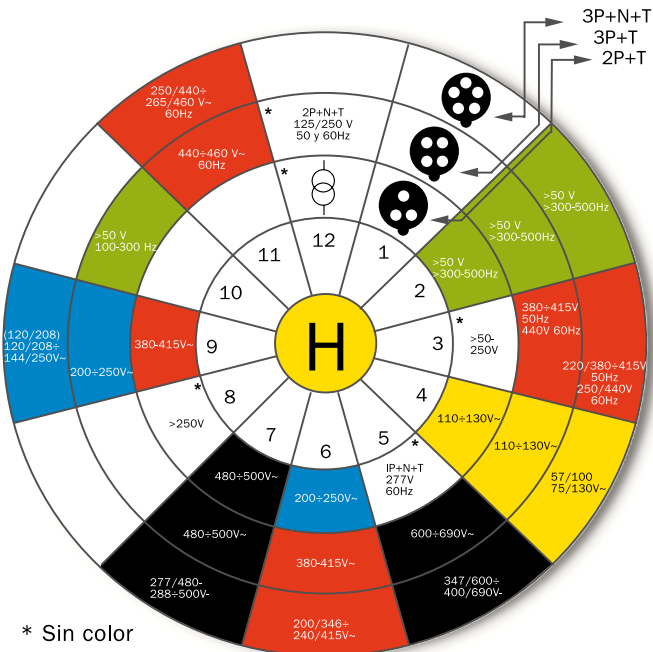
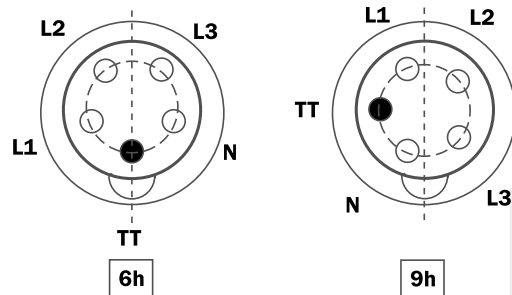

\* Sin color

**SERIE 10 IEC 309 IP44 C€**

Clavijas de montaje y cableado rápido de baja tensión 50/60 Hz

Low voltage plugs 50/60 Hz

	Polos/ poles	I (A)	Tensión/ voltage (V)		H	Embalaje/pack carton
Ref. Item. 13100*	2P+T	16	110+130	■	4	10/160
Ref. Item. 13101*	3P+T	16	110+130	■	4	10/160
Ref. Item. 13102*	2P+T	32	110+130	■	4	5/80
Ref. Item. 13103*	3P+T	32	110+130	■	4	5/80
Ref. Item. 13200	2P+T	16	220+240	■	6	10/160
Ref. Item. 13201*	3P+T	16	220+240	■	9	10/160
Ref. Item. 13202*	3P+N+T	16	220+240	■	9	8/128
Ref. Item. 13203	2P+T	32	220+240	■	6	5/80
Ref. Item. 13204*	3P+T	32	220+240	■	9	5/80
Ref. Item. 13300	3P+T	16	380+415	■	6	10/160
Ref. Item. 13301	3P+N+T	16	380+415	■	6	8/128
Ref. Item. 13302	3P+T	32	380+415	■	6	5/80
Ref. Item. 13303	3P+N+T	32	380+415	■	6	5/80
Ref. Item. 13400*	3P+T	16	500	■	7	10/160
Ref. Item. 13401*	3P+N+T	16	500	■	7	8/128
Ref. Item. 13402*	3P+T	32	500	■	7	5/80
Ref. Item. 13403*	3P+N+T	32	500	■	7	5/80

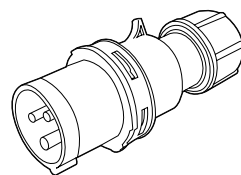

**SERIE 10 IEC 309 IP67 CE**

Clavijas de montaje y cableado rápido de baja tensión 50/60 Hz

Low voltage plugs 50/60 Hz

	Polos/ poles	I (A)	Tensión/ voltage (V)		H	Embalaje/pack carton
Ref. Item. 14100*	2P+T	16	110+130	■	4	10/160
Ref. Item. 14101*	3P+T	16	110+130	■	4	8/128
Ref. Item. 14102*	2P+T	32	110+130	■	4	4/64
Ref. Item. 14103*	3P+T	32	110+130	■	4	4/64
Ref. Item. 14200	2P+T	16	220+240	■	6	10/160
Ref. Item. 14201*	3P+T	16	220+240	■	9	8/128
Ref. Item. 14202*	3P+N+T	16	220+240	■	9	6/96
Ref. Item. 14203	2P+T	32	220+240	■	6	4/64
Ref. Item. 14204*	3P+T	32	220+240	■	9	4/64
Ref. Item. 14300	3P+T	16	380+415	■	6	8/128
Ref. Item. 14301	3P+N+T	16	380+415	■	6	6/96
Ref. Item. 14302	3P+T	32	380+415	■	6	4/64
Ref. Item. 14303	3P+N+T	32	380+415	■	6	3/48
Ref. Item. 14304	3P+T	63	380+415	■	6	10/10
Ref. Item. 14305	3P+N+T	63	380+415	■	6	10/10
Ref. Item. 14306	3P+T	125	380+415	■	6	10/10
Ref. Item. 14307	3P+N+T	125	380+415	■	6	10/10
Ref. Item. 14400*	3P+T	16	500	■	7	8/128
Ref. Item. 14401*	3P+N+T	16	500	■	7	6/96
Ref. Item. 14402*	3P+T	32	500	■	7	4/64
Ref. Item. 14403*	3P+N+T	32	500	■	7	4/64

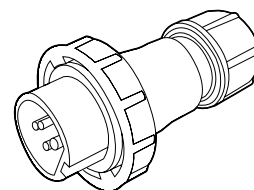
72  
73

Famatec

**SERIE 10 IEC 309 IP44 CE**

Clavijas de bajísima tensión

Extra low voltage plugs

	Polos/ poles	Hz	I (A)	Tensión/voltage (V)		Embalaje/pack carton
Ref. Item. 13800	2P	50/60	16	24 (20-25)	■	10/160
Ref. Item. 13801*	3P	50/60	16		■	10/160
Ref. Item. 13900*	2P	50/60	16	42 (40-50)		10/160
Ref. Item. 13901*	3P	50/60	16			10/160
Ref. Item. 13700*	2P	100/200	16	24 (20-25)	■	10/160
Ref. Item. 13701*	3P	100/200	16		■	10/160
Ref. Item. 13702*	2P	401/500	16	42 (40-50)	■	10/160
Ref. Item. 13703*	3P	401/500	16		■	10/160
Ref. Item. 13820*	2P	50/60	32	24 (20-25)	■	10/160
Ref. Item. 13821*	3P	50/60	32		■	10/160
Ref. Item. 13920*	2P	50/60	32	42 (40-50)		10/160
Ref. Item. 13921*	3P	50/60	32			10/160
Ref. Item. 13720*	2P	100/200	32	24 (20-25)	■	10/160
Ref. Item. 13721*	3P	100/200	32		■	10/160
Ref. Item. 13722*	2P	401/500	32	42 (40-50)	■	10/160
Ref. Item. 13723*	3P	401/500	32		■	10/160

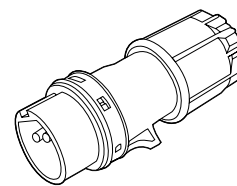

**SERIE 10 IEC 309 IP67 CE**Clavijas de bajísima tensión  
Extra low voltage plugs

	Polos/poles	Hz	I (A)	Tensión/voltage (V)		Embalaje/pack carton
Ref. Item. 14800	2P	50/60	16		■	10/160
Ref. Item. 14801*	3P	50/60	16	24 (20-25)	■	10/160
Ref. Item. 14900*	2P	50/60	16			10/160
Ref. Item. 14901*	3P	50/60	16	42 (40-50)		10/160
Ref. Item. 14700*	2P	100/200	16		■	10/160
Ref. Item. 14701*	3P	100/200	16	24 (20-25)	■	10/160
Ref. Item. 14702*	2P	401/500	16		■	10/160
Ref. Item. 14703*	3P	401/500	16	42 (40-50)	■	10/160
Ref. Item. 14820*	2P	50/60	32		■	10/160
Ref. Item. 14821*	3P	50/60	32	24 (20-25)	■	10/160
Ref. Item. 14920*	2P	50/60	32			10/160
Ref. Item. 14921*	3P	50/60	32	42 (40-50)		10/160
Ref. Item. 14720*	2P	100/200	32		■	10/160
Ref. Item. 14721*	3P	100/200	32	24 (20-25)	■	10/160
Ref. Item. 14722*	2P	401/500	32		■	10/160
Ref. Item. 14723*	3P	401/500	32	42 (40-50)	■	10/160

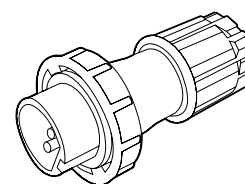

**SERIE 10 IEC 309 IP44 CÉ**

 Clavijas fijas de pared de baja tensión 50/60 Hz  
 Low voltage plugs 50/60 Hz

	Polos/ poles	I (A)	Tensión/ voltage (V)		H	Embalaje/pack carton
Ref. Item. 13150*	2P+T	16	110÷130	■	4	4/64
Ref. Item. 13151*	3P+T	16	110÷130	■	4	4/64
Ref. Item. 13152*	2P+T	32	110÷130	■	4	2/32
Ref. Item. 13153*	3P+T	32	110÷130	■	4	2/32
Ref. Item. 13250	2P+T	16	220÷240	■	6	4/64
Ref. Item. 13251*	3P+T	16	220÷240	■	9	4/64
Ref. Item. 13252*	3P+N+T	16	220÷240	■	9	2/32
Ref. Item. 13253	2P+T	32	220÷240	■	6	2/32
Ref. Item. 13254*	3P+T	32	220÷240	■	9	2/32
Ref. Item. 13350	3P+T	16	380÷415	■	6	4/64
Ref. Item. 13351	3P+N+T	16	380÷415	■	6	2/32
Ref. Item. 13352	3P+T	32	380÷415	■	6	2/32
Ref. Item. 13353	3P+N+T	32	380÷415	■	6	2/32
Ref. Item. 13450*	3P+T	16	500	■	7	4/64
Ref. Item. 13451*	3P+N+T	16	500	■	7	2/32
Ref. Item. 13452*	3P+T	32	500	■	7	2/32
Ref. Item. 13453*	3P+N+T	32	500	■	7	2/32

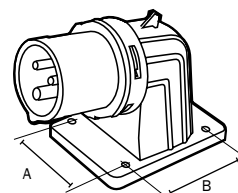

	16A	32A
A	52	77
B	61	85

**Clavijas fijas a 90°**  
**Panel mounting plugs 90°**

**SERIE 10 IEC 309 IP67 CE**

Clavijas fijas de pared de baja tensión 50/60 Hz

Low voltage plugs 50/60 Hz

	Polos/ poles	I (A)	Tensión/ voltage (V)		H	Embalaje/pack carton
Ref. Item. 14150*	2P+T	16	110÷130	■	4	4/64
Ref. Item. 14151*	3P+T	16	110÷130	■	4	4/64
Ref. Item. 14152*	2P+T	32	110÷130	■	4	2/32
Ref. Item. 14153*	3P+T	32	110÷130	■	4	2/32
Ref. Item. 14250	2P+T	16	220÷240	■	6	4/64
Ref. Item. 14251*	3P+T	16	220÷240	■	9	4/64
Ref. Item. 14252*	3P+N+T	16	220÷240	■	9	4/64
Ref. Item. 14253	2P+T	32	220÷240	■	6	2/32
Ref. Item. 14254*	3P+T	32	220÷240	■	9	2/32
Ref. Item. 14350	3P+T	16	380÷415	■	6	4/64
Ref. Item. 14351	3P+N+T	16	380÷415	■	6	4/64
Ref. Item. 14352	3P+T	32	380÷415	■	6	2/32
Ref. Item. 14353	3P+N+T	32	380÷415	■	6	2/32
Ref. Item. 14450*	3P+T	16	500	■	7	4/64
Ref. Item. 14451*	3P+N+T	16	500	■	7	2/32
Ref. Item. 14452*	3P+T	32	500	■	7	2/32
Ref. Item. 14453*	3P+N+T	32	500	■	7	2/32

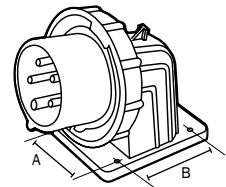

	16A	32A
A	52	77
B	61	85

76  
77

Famatec

**SERIE 11 IEC 309 IP44 CE**

Bases de montaje baja tensión 50/60 Hz

Low voltage connectors 50/60 Hz

	Polos/ poles	I (A)	Tensión/ voltage (V)		H	Embalaje/pack carton
Ref. Item. 23100*	2P+T	16	110÷130	■	4	10/160
Ref. Item. 23101*	3P+T	16	110÷130	■	4	10/160
Ref. Item. 23102*	2P+T	32	110÷130	■	4	4/64
Ref. Item. 23103*	3P+T	32	110÷130	■	4	4/64
Ref. Item. 23200	2P+T	16	220÷240	■	6	20/160
Ref. Item. 23201*	3P+T	16	220÷240	■	9	10/160
Ref. Item. 23202*	3P+N+T	16	220÷240	■	9	5/-
Ref. Item. 23203	2P+T	32	220÷240	■	6	4/64
Ref. Item. 23204*	3P+T	32	220÷240	■	9	4/64
Ref. Item. 23300	3P+T	16	380÷415	■	6	10/160
Ref. Item. 23301	3P+N+T	16	380÷415	■	6	5/80
Ref. Item. 23302	3P+T	32	380÷415	■	6	4/64
Ref. Item. 23303	3P+N+T	32	380÷415	■	6	4/64
Ref. Item. 23400*	3P+T	16	500	■	7	10/160
Ref. Item. 23401*	3P+N+T	16	500	■	7	5/80
Ref. Item. 23402*	3P+T	32	500	■	7	4/64
Ref. Item. 23403*	3P+N+T	32	500	■	7	5/80

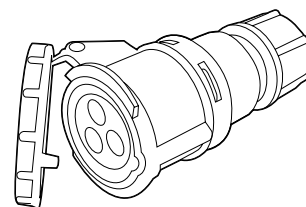

**SERIE 11 IEC 309 IP67 CE**

Bases de montaje baja tensión 50/60 Hz

Low voltage connectors 50/60 Hz

	Polos/ poles	I (A)	Tensión/ voltage (V)		H	Embalaje/pack carton
Ref. Item. 24100*	2P+T	16	110+130	■	4	10/160
Ref. Item. 24101*	3P+T	16	110+130	■	4	8/128
Ref. Item. 24102*	2P+T	32	110+130	■	4	4/64
Ref. Item. 24103*	3P+T	32	110+130	■	4	4/64
Ref. Item. 24200	2P+T	16	220+240	■	6	10/160
Ref. Item. 24201*	3P+T	16	220+240	■	9	8/128
Ref. Item. 24202*	3P+N+T	16	220+240	■	9	5/80
Ref. Item. 24203	2P+T	32	220+240	■	6	4/64
Ref. Item. 24204*	3P+T	32	220+240	■	9	4/64
Ref. Item. 24300	3P+T	16	380+415	■	6	8/128
Ref. Item. 24301	3P+N+T	16	380+415	■	6	4/64
Ref. Item. 24302	3P+T	32	380+415	■	6	4/64
Ref. Item. 24303	3P+N+T	32	380+415	■	6	3/48
Ref. Item. 24304	3P+T	63	380+415	■	6	10/10
Ref. Item. 24305	3P+N+T	63	380+415	■	6	10/10
Ref. Item. 24306	3P+T	125	380+415	■	6	10/10
Ref. Item. 24307	3P+N+T	125	380+415	■	6	10/10
Ref. Item. 24400*	3P+T	16	500	■	7	8/128
Ref. Item. 24401*	3P+N+T	16	500	■	7	4/64
Ref. Item. 24402*	3P+T	32	500	■	7	4/64
Ref. Item. 24403*	3P+N+T	32	500	■	7	3/48

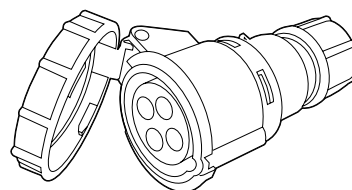

**SERIE 11 IEC 309 IP44 CE**

 Bases de bajísima tensión  
 Extra low voltage connectors

	Polos/ poles	Hz	I (A)	Tensión/voltage (V)		Embalaje/pack carton
Ref. Item. 23800	2P	50/60	16	24 (20-25)	■	10/160
Ref. Item. 23801*	3P	50/60	16		■	10/160
Ref. Item. 23900*	2P	50/60	16	42 (40-50)		10/160
Ref. Item. 23901*	3P	50/60	16			10/160
Ref. Item. 23700*	2P	100/200	16	24 (20-25)	■	10/160
Ref. Item. 23701*	3P	100/200	16		■	10/160
Ref. Item. 23702*	2P	401/500	16	42 (40-50)	■	10/160
Ref. Item. 23703*	3P	401/500	16		■	10/160
Ref. Item. 23820*	2P	50/60	32	24 (20-25)	■	10/160
Ref. Item. 23821*	3P	50/60	32		■	10/160
Ref. Item. 23920*	2P	50/60	32	42 (40-50)		10/160
Ref. Item. 23921*	3P	50/60	32			10/160
Ref. Item. 23720*	2P	100/200	32	24 (20-25)	■	10/160
Ref. Item. 23721*	3P	100/200	32		■	10/160
Ref. Item. 23722*	2P	401/500	32	42 (40-50)	■	10/160
Ref. Item. 23723*	3P	401/500	32		■	10/160

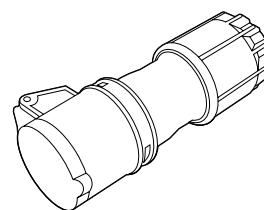

**SERIE 11 IEC 309 IP67 CE**

Bases de bajísima tensión

Extra low voltage connectors

	Polos/poles	Hz	I (A)	Tensión/voltage (V)		Embalaje/pack carton
Ref. Item. 24800	2P	50/60	16	24 (20-25)	■	10/160
Ref. Item. 24801*	3P	50/60	16		■	10/160
Ref. Item. 24900*	2P	50/60	16	42 (40-50)		10/160
Ref. Item. 24901*	3P	50/60	16			10/160
Ref. Item. 24700*	2P	100/200	16	24 (20-25)	■	10/160
Ref. Item. 24701*	3P	100/200	16		■	10/160
Ref. Item. 24702*	2P	401/500	16	42 (40-50)	■	10/160
Ref. Item. 24703*	3P	401/500	16		■	10/160
Ref. Item. 24820*	2P	50/60	32	24 (20-25)	■	10/160
Ref. Item. 24821*	3P	50/60	32		■	10/160
Ref. Item. 24920*	2P	50/60	32	42 (40-50)		10/160
Ref. Item. 24921*	3P	50/60	32			10/160
Ref. Item. 24720*	2P	100/200	32	24 (20-25)	■	10/160
Ref. Item. 24721*	3P	100/200	32		■	10/160
Ref. Item. 24722*	2P	401/500	32	42 (40-50)	■	10/160
Ref. Item. 24723*	3P	401/500	32		■	10/160

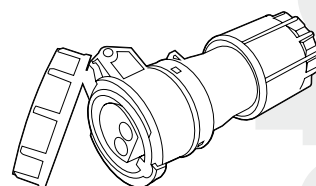
80  
81

# Famatec

**SERIE 11 IEC 309 IP44 CE**

Bases fijas de pared de baja tensión 50/60 Hz

Low voltage sockets 50/60 Hz

	Polos/ poles	I (A)	Tensión/ voltage (V)		H	Embalaje/pack carton
Ref. Item. 23150*	2P+T	16	110+130	■	4	4/64
Ref. Item. 23151*	3P+T	16	110+130	■	4	4/64
Ref. Item. 23152*	2P+T	32	110+130	■	4	2/32
Ref. Item. 23153*	3P+T	32	110+130	■	4	2/32
Ref. Item. 23250	2P+T	16	220+240	■	6	4/64
Ref. Item. 23251*	3P+T	16	220+240	■	9	4/64
Ref. Item. 23252*	3P+N+T	16	220+240	■	9	2/32
Ref. Item. 23253	2P+T	32	220+240	■	6	2/32
Ref. Item. 23254*	3P+T	32	220+240	■	9	2/32
Ref. Item. 23350	3P+T	16	380+415	■	6	4/64
Ref. Item. 23351	3P+N+T	16	380+415	■	6	2/32
Ref. Item. 23352	3P+T	32	380+415	■	6	2/32
Ref. Item. 23353	3P+N+T	32	380+415	■	6	2/32
Ref. Item. 23450*	3P+T	16	500	■	7	4/64
Ref. Item. 23451*	3P+N+T	16	500	■	7	2/32
Ref. Item. 23452*	3P+T	32	500	■	7	2/32
Ref. Item. 23453*	3P+N+T	32	500	■	7	2/32

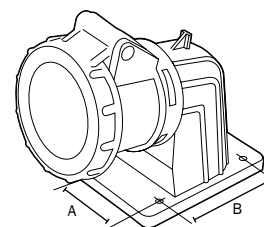

	16A	32A
A	52	77
B	61	85

**Bases fijas a 90°**
**Panel mounting sockets 90°**

\*Producto no disponible en stock, solo bajo pedido

**SERIE 11 IEC 309 IP67 CE**

Bases fijas de pared de baja tensión 50/60 Hz

Low voltage sockets 50/60 Hz

	Polos/ poles	I (A)	Tensión/ voltage (V)		H	Embalaje/pack carton
Ref. Item. 24150*	2P+T	16	110+130	■	4	4/64
Ref. Item. 24151*	3P+T	16	110+130	■	4	4/64
Ref. Item. 24152*	2P+T	32	110+130	■	4	2/32
Ref. Item. 24153*	3P+T	32	110+130	■	4	2/32
Ref. Item. 24250	2P+T	16	220+240	■	6	4/64
Ref. Item. 24251*	3P+T	16	220+240	■	9	4/64
Ref. Item. 24252*	3P+N+T	16	220+240	■	9	2/32
Ref. Item. 24253	2P+T	32	220+240	■	6	2/32
Ref. Item. 24254*	3P+T	32	220+240	■	9	2/32
Ref. Item. 24350	3P+T	16	380+415	■	6	4/64
Ref. Item. 24351	3P+N+T	16	380+415	■	6	2/32
Ref. Item. 24352	3P+T	32	380+415	■	6	2/32
Ref. Item. 24353	3P+N+T	32	380+415	■	6	2/32
Ref. Item. 24450*	3P+T	16	500	■	7	4/64
Ref. Item. 24451*	3P+N+T	16	500	■	7	2/32
Ref. Item. 24452*	3P+T	32	500	■	7	2/32
Ref. Item. 24453*	3P+N+T	32	500	■	7	2/32

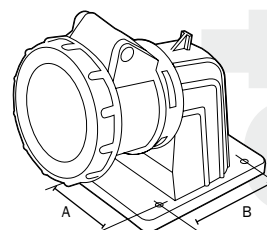
82  
83

	16A	32A
A	52	77
B	61	85

Famate

**SERIE 11 IEC 309 IP44 C€**

Bases fijas de inclinadas 10° de baja tensión 50/60 Hz

Low voltage sockets 50/60 Hz

	Polos/ poles	I (A)	Tensión/ voltage (V)		H	Embalaje/pack carton
Ref. Item. 23130*	2P+T	16	110÷130	■	4	10/160
Ref. Item. 23131*	3P+T	16	110÷130	■	4	10/160
Ref. Item. 23132*	2P+T	32	110÷130	■	4	5/80
Ref. Item. 23133*	3P+T	32	110÷130	■	4	5/80
Ref. Item. 23230	2P+T	16	220÷240	■	6	10/160
Ref. Item. 23231*	3P+T	16	220÷240	■	9	10/160
Ref. Item. 23232*	3P+N+T	16	220÷240	■	9	8/128
Ref. Item. 23233	2P+T	32	220÷240	■	6	5/80
Ref. Item. 23234*	3P+T	32	220÷240	■	9	5/80
Ref. Item. 23330	3P+T	16	380÷415	■	6	10/160
Ref. Item. 23331	3P+N+T	16	380÷415	■	6	8/128
Ref. Item. 23332	3P+T	32	380÷415	■	6	5/80
Ref. Item. 23333	3P+N+T	32	380÷415	■	6	5/80
Ref. Item. 23430*	3P+T	16	500	■	7	10/160
Ref. Item. 23431*	3P+N+T	16	500	■	7	8/128
Ref. Item. 23432*	3P+T	32	500	■	7	5/80
Ref. Item. 23433*	3P+N+T	32	500	■	7	5/80

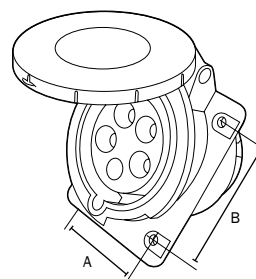

	16A	32A
A	60	62
B	60	70

**SERIE 11 IEC 309 IP67 CE**

Bases fijas inclinadas 10° de baja tensión 50/60 Hz

Low voltage sockets 50/60 Hz

	Polos/ poles	I (A)	Tensión/ voltage (V)		H	Embalaje/pack carton
Ref. Item. 24130*	2P+T	16	110+130	■	4	10/160
Ref. Item. 24131*	3P+T	16	110+130	■	4	8/128
Ref. Item. 24132*	2P+T	32	110+130	■	4	5/80
Ref. Item. 24133*	3P+T	32	110+130	■	4	5/80
Ref. Item. 24230	2P+T	16	220+240	■	6	10/160
Ref. Item. 24231*	3P+T	16	220+240	■	9	8/128
Ref. Item. 24232*	3P+N+T	16	220+240	■	9	8/128
Ref. Item. 24233	2P+T	32	220+240	■	6	5/80
Ref. Item. 24234*	3P+T	32	220+240	■	9	5/80
Ref. Item. 24330	3P+T	16	380+415	■	6	8/128
Ref. Item. 24331	3P+N+T	16	380+415	■	6	8/128
Ref. Item. 24332	3P+T	32	380+415	■	6	5/80
Ref. Item. 24333	3P+N+T	32	380+415	■	6	5/80
Ref. Item. 24334	3P+T	63	380+415	■	6	5/5
Ref. Item. 24335	3P+N+T	63	380+415	■	6	5/5
Ref. Item. 24337	3P+T	125	380+415	■	6	5/5
Ref. Item. 24338	3P+N+T	125	380+415	■	6	5/5
Ref. Item. 24430*	3P+T	16	500	■	7	8/128
Ref. Item. 24431*	3P+N+T	16	500	■	7	8/128
Ref. Item. 24432*	3P+T	32	500	■	7	5/80
Ref. Item. 24433*	3P+N+T	32	500	■	7	5/80

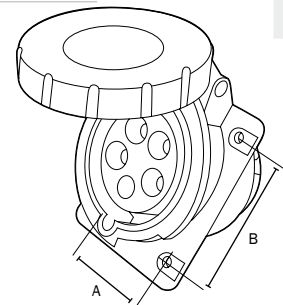

	16A	32A	63A	125A
A	60	62	80	100
B	60	70	88	108



**SERIE 11 IEC 309 IP44 C€**

Bases fijas rectas de bajísima tensión

Extra low voltage sockets

	Polos/poles	Hz	I (A)	Tensión/voltage (V)		Embalaje/pack carton
Ref. Item. 23870	2P	50/60	16	24 (20-25)	■	10/160
Ref. Item. 23871*	3P	50/60	16		■	10/160
Ref. Item. 23970*	2P	50/60	16	42 (40-50)		10/160
Ref. Item. 23971*	3P	50/60	16			10/160
Ref. Item. 23770*	2P	100/200	16	24 (20-25)	■	10/160
Ref. Item. 23771*	3P	100/200	16		■	10/160
Ref. Item. 23772*	2P	401/500	16	42 (40-50)	■	10/160
Ref. Item. 23773*	3P	401/500	16		■	10/160
Ref. Item. 23880*	2P	50/60	32	24 (20-25)	■	10/160
Ref. Item. 23881*	3P	50/60	32		■	10/160
Ref. Item. 23980*	2P	50/60	32	42 (40-50)		10/160
Ref. Item. 23981*	3P	50/60	32			10/160
Ref. Item. 23780*	2P	100/200	32	24 (20-25)	■	10/160
Ref. Item. 23781*	3P	100/200	32		■	10/160
Ref. Item. 23782*	2P	401/500	32	42 (40-50)	■	10/160
Ref. Item. 23783*	3P	401/500	32		■	10/160

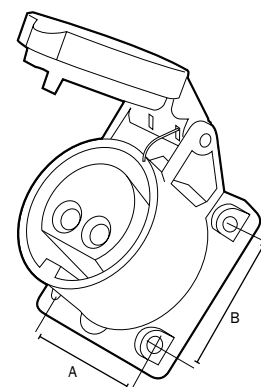

	16A	32A
A	45	45
B	45	45

\*Producto no disponible en stock, solo bajo pedido

**SERIE 11 IEC 309 IP67 CE**

Bases fijas rectas de bajísima tensión

Extra low voltage sockets

	P o l o s / p o l e s	Hz	I (A)	Tensión/voltage (V)	Embalaje/pack carton
Ref. Item. 24870	2P	50/60	16	24 (20-25)	10/160
Ref. Item. 24871*	3P	50/60	16		10/160
Ref. Item. 24970*	2P	50/60	16	42 (40-50)	10/160
Ref. Item. 24971*	3P	50/60	16		10/160
Ref. Item. 24770*	2P	100/200	16	24 (20-25)	10/160
Ref. Item. 24771*	3P	100/200	16		10/160
Ref. Item. 24772*	2P	401/500	16	42 (40-50)	10/160
Ref. Item. 24773*	3P	401/500	16		10/160
Ref. Item. 24880*	2P	50/60	32	24 (20-25)	10/160
Ref. Item. 24881*	3P	50/60	32		10/160
Ref. Item. 24980*	2P	50/60	32	42 (40-50)	10/160
Ref. Item. 24981*	3P	50/60	32		10/160
Ref. Item. 24780*	2P	100/200	32	24 (20-25)	10/160
Ref. Item. 24781*	3P	100/200	32		10/160
Ref. Item. 24782*	2P	401/500	32	42 (40-50)	10/160
Ref. Item. 24783*	3P	401/500	32		10/160

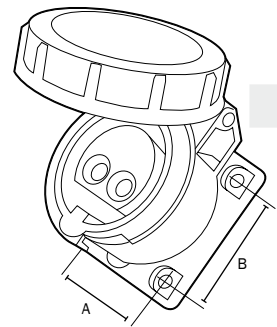

	16A	32A
A	45	45
B	45	45

86  
87

Famatec

**SERIE 11 IEC 309 IP44 CE**

Bases fijas rectas de baja tensión 50/60 Hz

Straight sockets 50/60 Hz

	Polos/ poles	I (A)	Tensión/ voltage (V)		H	Embalaje/ pack carton
Ref. Item. 23170*	2P+T	16	110+130	■	4	10/160
Ref. Item. 23171*	3P+T	16	110+130	■	4	10/160
Ref. Item. 23172*	2P+T	32	110+130	■	4	5/80
Ref. Item. 23173*	3P+T	32	110+130	■	4	5/80
Ref. Item. 23270	2P+T	16	220+240	■	6	10/160
Ref. Item. 23271*	3P+T	16	220+240	■	9	10/160
Ref. Item. 23272	2P+T	32	220+240	■	6	5/80
Ref. Item. 23273*	3P+T	32	220+240	■	9	5/80
Ref. Item. 23370	3P+T	16	380+415	■	6	10/160
Ref. Item. 23371	3P+N+T	16	380+415	■	6	8/128
Ref. Item. 23372	3P+T	32	380+415	■	6	5/80
Ref. Item. 23373	3P+N+T	32	380+415	■	6	5/80
Ref. Item. 23470*	3P+T	16	500	■	7	10/160
Ref. Item. 23471*	3P+N+T	16	500	■	7	8/128
Ref. Item. 23472*	3P+T	32	500	■	7	5/80
Ref. Item. 23473*	3P+N+T	32	500	■	7	5/80

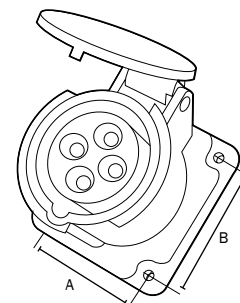

	16A	32A
A	60	60
B	60	60

**SERIE 11 IEC 309 IP67 CE**

Bases fijas rectas de baja tensión 50/60 Hz

Straight sockets 50/60 Hz

	Polos/ poles	I (A)	Tensión/ voltage (V)		H	Embalaje/pack carton
Ref. Item. 24170*	2P+T	16	110+130	■	4	8/128
Ref. Item. 24171*	3P+T	16	110+130	■	4	8/128
Ref. Item. 24172*	2P+T	32	110+130	■	4	4/64
Ref. Item. 24173*	3P+T	32	110+130	■	4	4/64
Ref. Item. 24270	2P+T	16	220+240	■	6	8/128
Ref. Item. 24271*	3P+T	16	220+240	■	9	8/128
Ref. Item. 24272	2P+T	32	220+240	■	6	4/64
Ref. Item. 24273*	3P+T	32	220+240	■	9	4/64
Ref. Item. 24370	3P+T	16	380+415	■	6	8/128
Ref. Item. 24371	3P+N+T	16	380+415	■	6	8/128
Ref. Item. 24372	3P+T	32	380+415	■	6	5/80
Ref. Item. 24373	3P+N+T	32	380+415	■	6	5/80
Ref. Item. 24374	3P+N+T	63	380+415	■	6	5/5
Ref. Item. 24375	3P+T	63	380+415	■	6	5/5
Ref. Item. 24470*	3P+T	16	500	■	7	8/128
Ref. Item. 24471*	3P+N+T	16	500	■	7	8/128
Ref. Item. 24472*	3P+T	32	500	■	7	5/80
Ref. Item. 24473*	3P+N+T	32	500	■	7	5/80

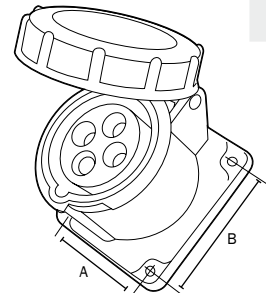

	16A	32A	63A
A	60	60	80
B	60	60	80

88  
89

Famatec

**SERIE 11 IEC 309 IP44 CE**

Bases fijas de pared inclinadas de baja tensión 50/60 Hz

Low voltage surface sockets 50/60 Hz

	Polos/ poles	I (A)	Tensión/ voltage (V)		H	Embalaje/pack carton
Ref. Item. 23190*	2P+T	16	110+130	■	4	3/48
Ref. Item. 23191*	3P+T	16	110+130	■	4	3/48
Ref. Item. 23192*	2P+T	32	110+130	■	4	2/32
Ref. Item. 23193*	3P+T	32	110+130	■	4	2/32
Ref. Item. 23290	2P+T	16	220+240	■	6	3/48
Ref. Item. 23291*	3P+T	16	220+240	■	9	3/48
Ref. Item. 23292	2P+T	32	220+240	■	6	2/32
Ref. Item. 23293*	3P+T	32	220+240	■	9	2/32
Ref. Item. 23390	3P+T	16	380+415	■	6	3/48
Ref. Item. 23391	3P+N+T	16	380+415	■	6	3/48
Ref. Item. 23392	3P+T	32	380+415	■	6	2/32
Ref. Item. 23393	3P+N+T	32	380+415	■	6	2/32
Ref. Item. 23490*	3P+T	16	500	■	7	3/48
Ref. Item. 23491*	3P+N+T	16	500	■	7	3/48
Ref. Item. 23492*	3P+T	32	500	■	7	2/32
Ref. Item. 23493*	3P+N+T	32	500	■	7	2/32

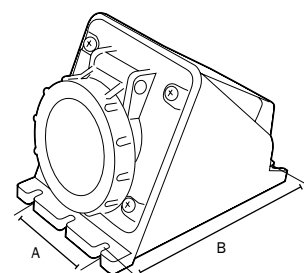

	16A	32A
A	56	56
B	122	122

### SERIE 11 IEC 309 IP67 CE

Bases fijas de pared inclinadas de baja tensión 50/60 Hz

Low voltage surface sockets 50/60 Hz

	Polos/ poles	I (A)	Tensión/ voltage (V)		H	Embalaje/pack carton
Ref. Item. 24190*	2P+T	16	110+130	■	4	3/48
Ref. Item. 24191*	3P+T	16	110+130	■	4	3/48
Ref. Item. 24192*	2P+T	32	110+130	■	4	2/32
Ref. Item. 24193*	3P+T	32	110+130	■	4	2/32
Ref. Item. 24290	2P+T	16	220+240	■	6	3/48
Ref. Item. 24291*	3P+T	16	220+240	■	9	3/48
Ref. Item. 24292	2P+T	32	220+240	■	6	2/32
Ref. Item. 24293*	3P+T	32	220+240	■	9	2/32
Ref. Item. 24390	3P+T	16	380+415	■	6	3/48
Ref. Item. 24391	3P+N+T	16	380+415	■	6	3/48
Ref. Item. 24392	3P+T	32	380+415	■	6	2/32
Ref. Item. 24393	3P+N+T	32	380+415	■	6	2/32
Ref. Item. 24394	3P+T	63	380+415	■	6	2/2
Ref. Item. 24395	3P+N+T	63	380+415	■	6	2/2
Ref. Item. 24396	3P+T	125	380+415	■	6	2/2
Ref. Item. 24397	3P+N+T	125	380+415	■	6	2/2
Ref. Item. 24490*	3P+T	16	500	■	7	3/48
Ref. Item. 24491*	3P+N+T	16	500	■	7	3/48
Ref. Item. 24492*	3P+T	32	500	■	7	2/32
Ref. Item. 24493*	3P+N+T	32	500	■	7	2/32



90  
91

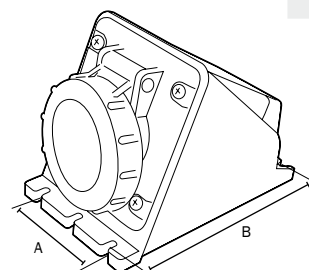

	16A	32A	63A	125A
A	56	56	122	140A
B	122	122	157	185

Famatec

**SERIE 12 IEC 309 IP67 CE**

Bases interbloccantes semi-empotrables verticales de baja tensión 50/60 Hz

Low tension interlocked sockets 50/60 Hz

	Polos/ poles	I (A)	Tensión/ voltage (V)		H	Embalaje/pack carton
Ref. Item. 25000	2P+T	16	220+240	■	6	1/1
Ref. Item. 25001	3P+T	16	380+415	■	6	1/1
Ref. Item. 25002	3P+N+T	16	380+415	■	6	1/1
Ref. Item. 25003	2P+T	32	220+240	■	6	1/1
Ref. Item. 25004	3P+T	32	380+415	■	6	1/1
Ref. Item. 25005	3P+N+T	32	380+415	■	6	1/1
Ref. Item. 25015	Caja para base interbloccante vertical Box for vertical interlocked sockets					1/1

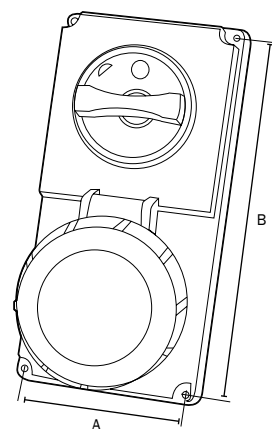

	16A	32A
A	79	79
B	172	172

### SERIE 12 IEC 309 IP67 CE

Bases interbloqueantes semi-empotrables horizontales de baja tensión 50/60 Hz  
Low tension interlocked sockets 50/60 Hz

	Polos/ poles	I (A)	Tensión/ voltage (V)		H	Embalaje/pack carton
Ref. Item. 25008	2P+T	16	220-240	■	6	1/1
Ref. Item. 25009	3P+T	16	380-415	■	6	1/1
Ref. Item. 25010	3P+N+T	16	380-415	■	6	1/1
Ref. Item. 25011	2P+T	32	220-240	■	6	1/1
Ref. Item. 25012	3P+T	32	380-415	■	6	1/1
Ref. Item. 25013	3P+N+T	32	380-415	■	6	1/1
Ref. Item. 25014	Caja para base interbloqueante horizontal Box for horizontal interlocked sockets					1/1

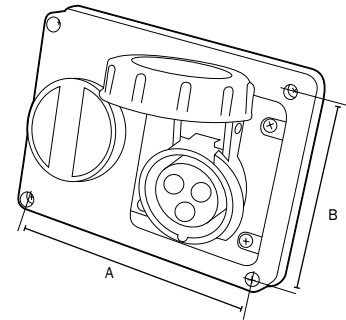

	16A	32A
A	138	138
B	98	98



92  
93

### SERIE 12 IEC 309 IP67 CE

Bases interbloqueantes de superficie horizontales de baja tensión 50/60 Hz  
Low tension interlocked sockets 50/60 Hz

	Polos/ poles	I (A)	Tensión/ voltage (V)		H	Embalaje/pack carton
Ref. Item. 25108	2P+T	16	220-240	■	6	1/1
Ref. Item. 25109	3P+T	16	380-415	■	6	1/1
Ref. Item. 25110	3P+N+T	16	380-415	■	6	1/1
Ref. Item. 25111	2P+T	32	220-240	■	6	1/1
Ref. Item. 25112	3P+T	32	380-415	■	6	1/1
Ref. Item. 25113	3P+N+T	32	380-415	■	6	1/1

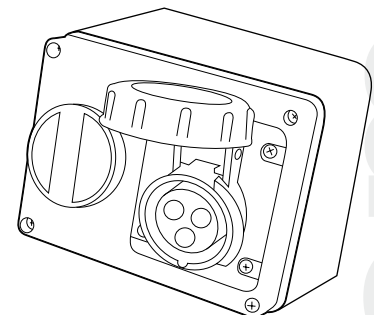

Famatec

**SERIE 12 IEC 309 IP67 CE**

Bases interbloqueantes superficie de baja tensión 50/60 Hz

Low tension interlocked sockets 50/60 Hz

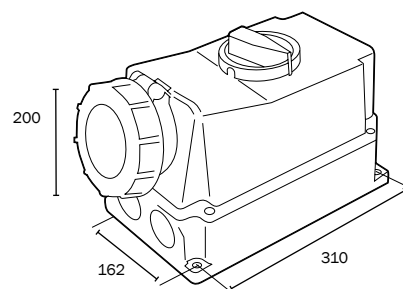

	Polos/ poles	I (A)	Tensión/ voltage (V)		H	Embalaje/pack carton
Ref. Item. 25006	3P+T	63	380+415	■	6	1/1
Ref. Item. 25007	3P+N+T	63	380+415	■	6	1/1



**SERIE 12 IEC 309 IP44 C€**

Adaptador múltiple de 2 tomas de baja tensión 50/60 Hz

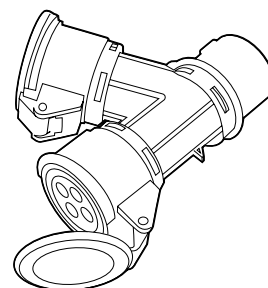

Multiple adaptor low voltage 50/60 Hz

	Polos/ poles	I (A)	Tensión/ voltage (V)		Embalaje/pack carton
Ref. Item. 15000	2P+T	16	220+240		4/4
Ref. Item. 15001	3P+T	16	380+415		4/4

**SERIE 12 IEC 309 IP67 C€**

Adaptador múltiple de 2 tomas de baja tensión 50/60 Hz

Multiple adaptor low voltage 50/60 Hz

	Polos/ poles	I (A)	Tensión/ voltage (V)		Embalaje/pack carton
Ref. Item. 16000	2P+T	16	220+240		4/4
Ref. Item. 16001	3P+T	16	380+415		4/4

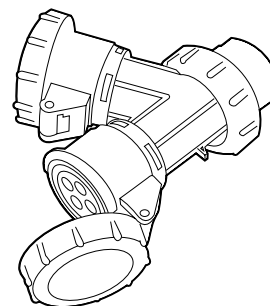

**SERIE 12 IEC 309 IP44 CE**

Adaptador múltiple con salida de 1 toma 16A 2P+TTL 220V  
*Multiple adaptor low voltage 50/60 Hz*

	Polos/ poles	I (A)	Tensión/ voltage (V)	Embalaje/pack carton
Ref. Item. 15002	2P+T	16	220+240	4/4

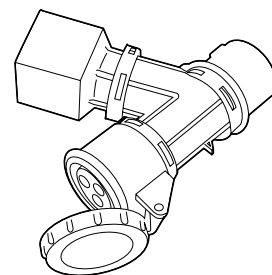
**SERIE 12 IEC 309 IP44 CE**

Adaptador múltiple de baja tensión  
*Multiple adaptor low voltage 50/60 Hz*

	Descripción/Description	Embalaje/pack carton
Ref. Item. 15003	Entrada/entry: 3P+N+T 16A Salida/exit: 1 toma 3P+T 16A + 1 toma 2P+T 16A	4/4
Ref. Item. 15004	Entrada/entry: 3P+N+T 16A Salida/exit: 2 tomas 2P+T 16A	4/4
Ref. Item. 15005	Entrada/entry: 3P+N+T 16A Salida/exit: 2 tomas 3P+T 16A	4/4

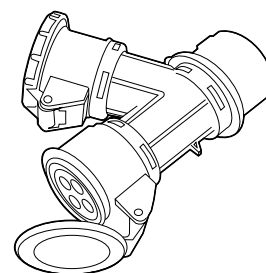

**SERIE 12 IEC 309 IP67** ☺

Adaptador múltiple de baja tensión 50/60 Hz  
 Multiple adaptor low voltage 50/60 Hz

	Descripción/Description	Embalaje/pack carton
Ref. Item. 16006	Entrada/entry: 3P+N+T 16A Salida/exit: 1 toma 3P+T 16A + 1 toma 2P+T 16A	4/4
Ref. Item. 16007	Entrada/entry: 3P+N+T 16A Salida/exit: 2 tomas 2P+T 16A	4/4
Ref. Item. 16008	Entrada: 3P+N+T 16A Salida: 2 tomas 3P+T 16A	4/4

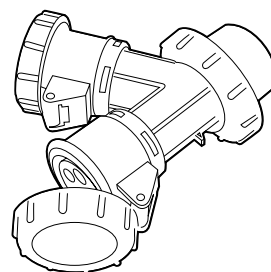

96  
97

**SERIE 13 IEC 309 IP44** ☺

Adaptador múltiple de 3 tomas de baja tensión 50/60 Hz  
 Multiple adaptor low tension 50/60 Hz

	Polos/ poles	I (A)	Tensión/ voltage (V)		Embalaje/pack carton
Ref. Item. 15006	2P+T	16	220÷240	■	2/2
Ref. Item. 15007	3P+T	16	380÷415	■	2/2
Ref. Item. 15008	3P+N+T	16	380÷415	■	2/2
Ref. Item. 15010	3P+T	32	380÷415	■	4/4
Ref. Item. 15009	3P+N+T	32	380÷415	■	4/4

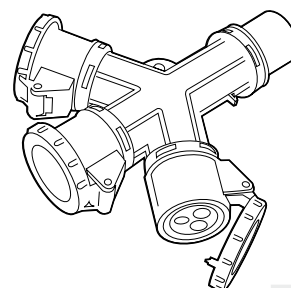

Famatec

**SERIE 13 IEC 309 IP67 CE**

Adaptador múltiple de 3 tomas de baja tensión 50/60 Hz

*Multiple adaptor low tension 50/60 Hz*

	Polos/ poles	I (A)	Tensión/ voltage (V)		Embalaje/pack carton
Ref. Item. 16002	2P+T	16	220÷240	■	2/2
Ref. Item. 16003	3P+T	16	380÷415	■	2/2
Ref. Item. 16004	3P+N+T	16	380÷415	■	2/2
Ref. Item. 16009	3P+T	32	380÷415	■	4/4
Ref. Item. 16005	3P+N+T	32	380÷415	■	4/4

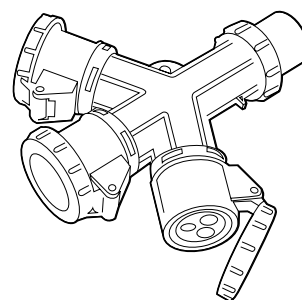
**SERIE 13 IEC 309 IP44 CE**

Adaptador múltiple con salida de 1 toma 16A 2P +TTL 220V

*Multiple adaptor low tension 1 way 16A 2P + TTL 220V*

	Polos/ poles	I (A)	Tensión/ voltage (V)		Embalaje/pack carton
Ref. Item. 16010	2P+T	16	220÷240	■	2/2

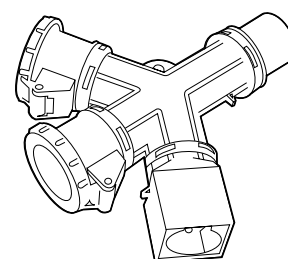

Adaptador industrial-doméstico IP40 CE  
Industrial-domestic adaptor IP40

	Descripción Description	Embalaje/pack carton
Ref. Item. 13913	Entrada/Entry: 2P+T 16A 250V Salida/Exit: 3 tomas/sockets 2P+TTL 16A 250V	10/60

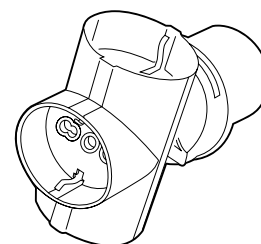

Adaptador industrial-doméstico IP40 CE  
Industrial-domestic adaptor IP40

	Descripción Description	Embalaje/pack carton
Ref. Item. 13910	Entrada/Entry: 2P+T 16A 250V Salida/Exit: 1 toma/socket 2P+T 16A 250V	10/160
Ref. Item. 13910-F	Entrada/Entry: 2P+T 16A 250V Salida/Exit: 1 toma/socket 2P+T 16A 250V french type	10/160

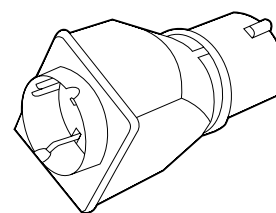

Adaptador doméstico-industrial IP40 CE  
Domestic-industrial adaptor IP40

	Descripción Description	Embalaje/pack carton
Ref. Item. 13912	Entrada/Entry: 2P+TTL 16A 250V Salida/Exit: 1 toma/socket 2P+T 250V	12/120

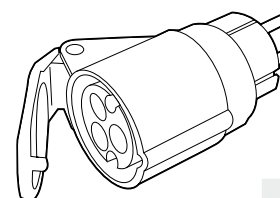

Toma de corriente 16A 2P+TTL **IP44** CÉ  
 Socket 16A 2P+TTL **IP44**

	Polos/ poles	I (A)	Tensión/ voltage (V)		Embalaje/pack carton
Ref. Item. 13950	2P+TTL	16	220+240	■	50/250
Ref. Item. 13951	2P+T	16	220+240	■	50/250

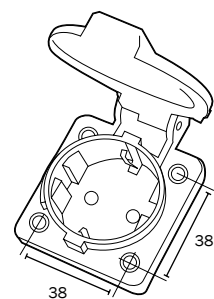

Toma de corriente 16A 2P+TTL **IP67** CÉ  
 Socket 16A 2P+TTL **IP67**

	Polos/ poles	I (A)	Tensión/ voltage (V)		Embalaje/pack carton
Ref. Item. 13960	2P+TTL	16	220+240	■	50/250

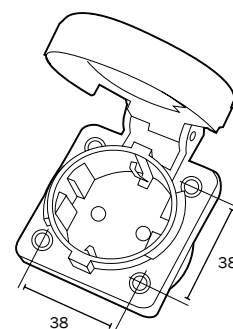

Toma de corriente 16A 2P+TTL IP67 CE  
 Socket 16A 2P+TTL IP67

	Polos/ poles	I (A)	Tensión/ voltage (V)	Embalaje/pack carton
Ref. Item. 13960-F	2P+TTL	16	220+240	■ 50/250

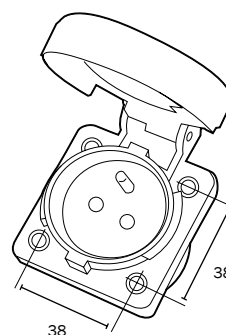

100  
101

Toma de corriente 16A 2P+TTL IP67 CE  
 Socket 16A 2P+TTL IP67

	Polos/ poles	I (A)	Tensión/ voltage (V)	Embalaje/pack carton
Ref. Item. 23960	2P+TTL	16	220+240	■ 12/72

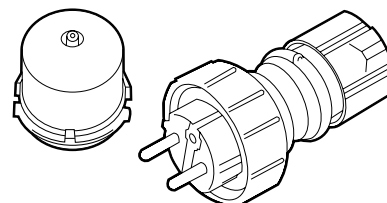

Famatec

Ref. Item. 1107

**CLAVIJA PLUG IP-44**

Clavija Bipolar con doble contacto de tierra  
 16 A - 250V. Goma Color Negro  
*Plug 2 poles + Earth 16 A - 250V.  
 Black Colour Rubber*

■	■
1	10



**NOVEDAD!**  
**NEW!**

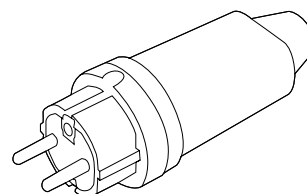

Ref. Item. 2108

**BASE SOCKET IP-44**

Base Bipolar + TT lateral 16 A - 250V  
 Goma Color Negro  
*Socket 2 poles + Earth 16 A - 250V.  
 Black Colour Rubber*

■	■
1	10



**NOVEDAD!**  
**NEW!**

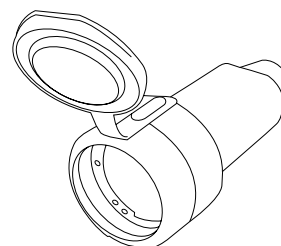

Ref. Item. 2109

**BASE SOCKET IP-44**

Base Bipolar con espiga contacto de tierra  
16 A - 250 V.  
Goma Color Negro.  
French socket 2 poles + Earth  
16 A - 250 V.  
Black Colour Rubber

■	■
1	10



**NOVEDAD**  
**NEW**

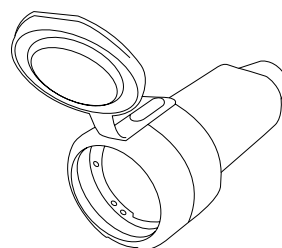

102  
103

Ref. Item. 187

**ADAPTADOR ADAPTOR IP-44**

Adaptador triple Bipolar IP44 + TT lateral  
16 A - 250 V.  
Goma Color Negro.  
Triple adaptor 2 poles IP44 + Earth  
16 A - 250 V.  
Black Colour Rubber

■	■
1	10



**NOVEDAD**  
**NEW**

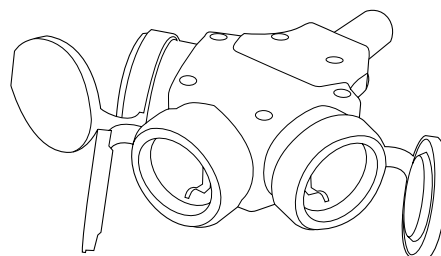

Famatec

Ref. Item. 30009

**ENROLLACABLE CABLE REEL IP-40**

 4 tomas 2P+TT Lateral 16A-250V con disyuntor. Prolongación 25m H05VV-F sección 3x1,5mm<sup>2</sup>

 4 sockets 2P+Earth 16A-250V with safety cutout. Cable 25m H05VV-F section 3x1,5mm<sup>2</sup>

■	■
1	1

Ref.Item 30010

**ENROLLACABLE CABLE REEL IP-40**

 4 tomas 2P+TT Lateral 16A-250V con disyuntor.Prolongación 50m H05VV-F sección 3x1,5mm<sup>2</sup>

 4 sockets 2P+Earth 16A-250V with safety cutout. Cable 50m H05VV-F section 3x1,5mm<sup>2</sup>

■	■
1	1

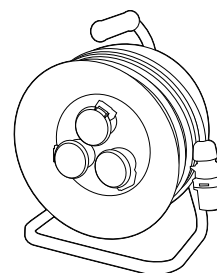

Ref. Item. 30013

**ENROLLACABLE CABLE REEL IP-67**

 4 tomas IP-67 2P+TT Lateral 16A-250V con disyuntor. Prolongación 30m H07RN-F sección 3x1,5mm<sup>2</sup>

 Salida clavija 2P+TTL 16A -250V  
 4 sockets 2P+Earth 16A-250V with safety cutout. Cable 30m H07RN-F section 3x1,5mm<sup>2</sup>  
 Exit plug 2P+TTL 16A 250V

■	■
1	1

Ref.Item 30014

**ENROLLACABLE CABLE REEL IP-67**

 4 tomas IP-67 2P+TT Lateral 16A-250V con disyuntor.Prolongación 50m H07RN-F sección 3x1,5mm<sup>2</sup>

 Salida clavija 2P+TTL 16A -250V  
 4 sockets 2P+Earth 16A-250V with safety cutout. Cable 50m H07RN-F section 3x1,5mm<sup>2</sup>  
 Exit plug 2P+TTL 16A 250V

■	■
1	1

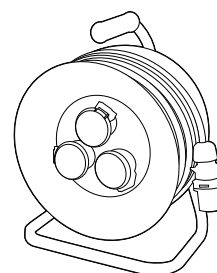

Ref. Item. 30015

**ENROLLACABLE CABLE REEL IP-40**

 4 tomas IP67 2P+TT Lateral 16A-250V con disyuntor.Prolongación 50m H07RN-F sección 3x1,5mm<sup>2</sup>

 Salida clavija CEE 2P+T 16A-250V  
 4 sockets IP-67 2P+Earth 16A-250V with safety cutout. Cable 50m H07RN-F section 3x1,5mm<sup>2</sup>  
 Exit CEE plug 2P+T 16A-250V

■	■
1	1

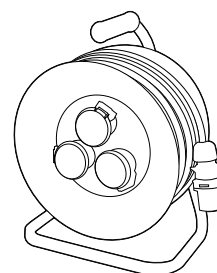

Ref. Item. 30016



**ENROLLACABLE CABLE REEL IP-67**

4 tomas IP67 2P+TT Lateral 16A-250V con disyuntor + diferencial magnetotermico 16A. Prolongación 30m H07RN-F sección 3x1,5mm<sup>2</sup>  
Salida clavija 2P+TTL 16A-250V  
4 sockets IP-67 2P+Earth 16A-250V with safety cutout+RCCB+MCB compaq circuit breaker 16A. Cable 30m H07RN-F section 3x1,5mm<sup>2</sup>  
Exit plug 2P+TTL 16A-250V

■	■
1	1

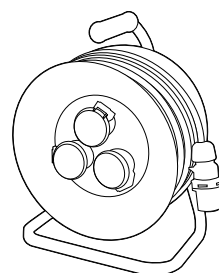

Ref. Item. 30002



**ENROLLACABLE CABLE REEL IP-67**

3 tomas IP67 2P+T 16A-250V con disyuntor. Prolongación 30m H07RN-F sección 3x2,5mm<sup>2</sup>  
Salida clavija CEE 2P+T 16A-250V  
3 sockets IP-67 2P+Earth 16A-250V with safety cutout. Cable 30m H07RN-F section 3x2,5mm<sup>2</sup>  
Exit CEE plug 2P+T 16A-250V

■	■
1	1

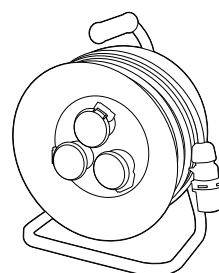

Ref. Item. 30004



**ENROLLACABLE CABLE REEL IP-67**

3 tomas IP67 3P+T 16A-250V con disyuntor. Prolongación 30m H07RN-F sección 4x2,5mm<sup>2</sup>  
Salida clavija CEE 3P+T 16A-250V  
3 sockets IP-67 3P+Earth 16A-250V with safety cutout. Cable 30m H07RN-F section 4x2,5mm<sup>2</sup>  
Exit CEE plug 3P+T 16A-250V

■	■
1	1

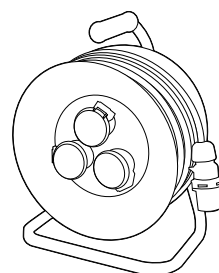

104  
105